

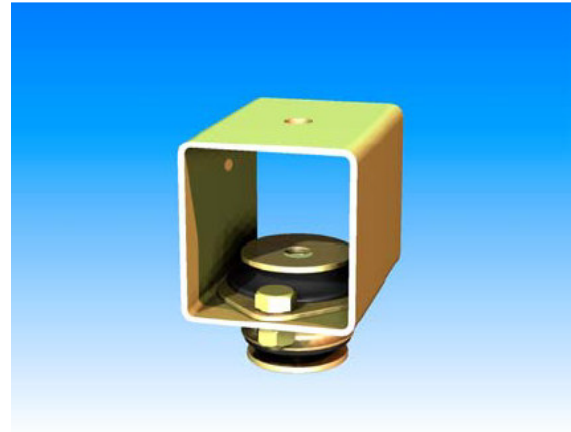

PH-4 Hanger

PH-4 Hanger-Elements are typically used to isolate suspended fans, ductwork, fan-cool units, packaged air-conditioners, pipes, etc. They are also very effective for the support of suspended ceilings where acoustical isolation is required. The static deflection ranges from 1 to 4 mm. and features protection against complete loss of support in the event of mechanical or fire damage.



Load Capacity: 66 to 675 lbs.

Applications: hanger-elements for piping, acoustic ceilings, fans, air-conditioning units, sensitive equipment, etc.

CROSS-SECTION

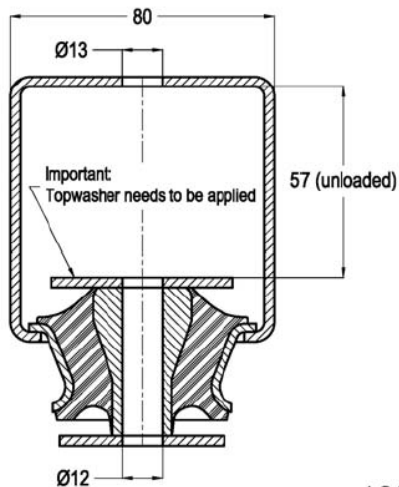

SIDEVIEW

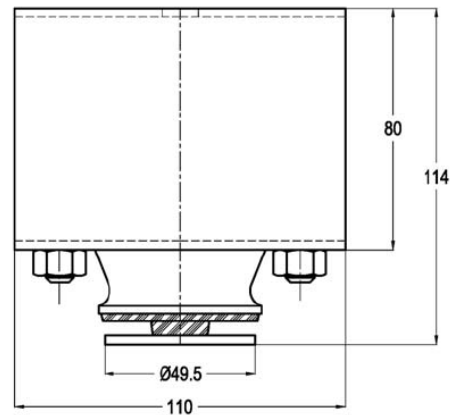

LOAD CHARACTERISTICS

